



BUILT - IN COFFEEMAKER

Installation & Operation guide

LV-68E75GB

LV-N68E75GB

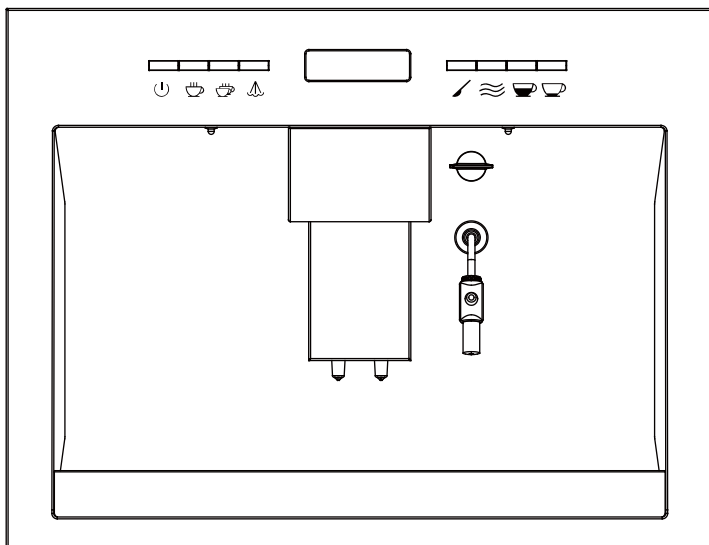

Safety instructions

1. Read and preserve the instructions carefully.
2. Keep the machine in a stable flat, which is dry and ventilated and out of reach of children.
3. Understand the power's specification before using the machine and then connect the power according to the requirement.
4. Don't use the machine when it is short of water or runs out of water.
5. Dispose the plastic and bubble board in the package appropriately to avoid hurting children
6. Don't keep the hot water /steam muzzle towards person or other items.
7. Disassemble the coffee-making machine and wash each unit only when the powder is turned off and the machine is cooled.
8. Don't use wet dishcloth to clean the machine shell.
9. Don't continue to use the machine when it is broken or the wire is broken. send it to the professional repairing shops or special shops in time.
10. It is normal phenomenon of nature examination to find little residual powder or water drops after purchasing the coffee machine in the first use.
11. The machine isn't applicable to the following groups, deficiencies in physical, feelings and mental, including children. Except that they are under the directions of their guardian to operate the machine safely and avoid playing with the machine for fun.

Product instruction

Model: RB45C

Voltage:AC220V-AC240V

Frequency:50/60HZ

Rated powder:1200-1500W

Capacity of water tank:2000 ml

Capacity of bean container:250g

Capacity of coffee dripping:30-240ml/cup

Features of Product

Perfect combination of high quality and practical use, with streamlined design, removable brewing Unit /water tank/dump container, simple operations and the usage to make milk frother for fancy coffee and other hot drinks. the main functions are quoted as follows:

LCD function

Touch display screen

Single-brewing function

Double-brewing function

Coffee powder brewing function

Auto-washing function

Cup-volume adjusting function

Coffee powder fineness adjusting function

Coffee-power volume adjusting function

Cups-counting function

Introductions to each unit

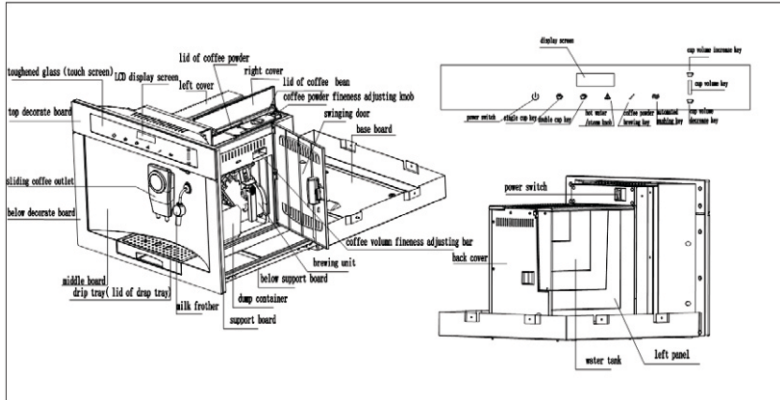

Operational instructions and maintenance

1. Fill the water tank with fresh water .

Revolve the left lid according to the arrow direction, pull the handle of water tank straightly and take it out, then fill the tank with pure water.

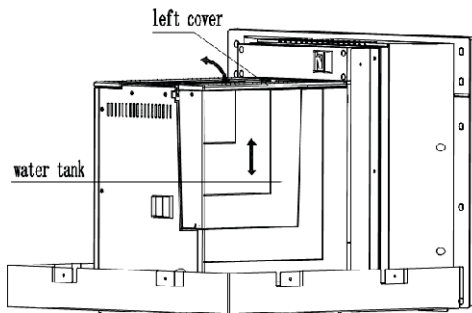

2. Press the power switch

2.1 Check to make sure the plug must be in line with the socket.

2.2 Press the power switch, meanwhile, the display screen will show "welcome"

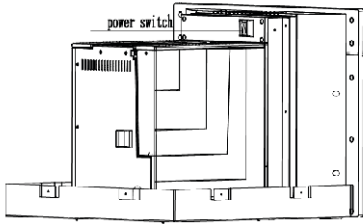

3. Basic operations of functional keys

Before using, the machine should be through self-testing, the procedures are as follows:

press the power switch, the display screen will show “self-testing” and the machine will finish the process automatically.

After that ,the machine will enter heating mode, at this moment, the screen will present heating” ,and it will last for one minute.

When heating is completed , the screen will present” ready”.

The next step is to release the hot water: revolve the hot water knob in the clockwise direction to release, in the opposite direction, it will be closed .

Check if there is bean in the bean hopper.

The coffee machine will enter into the brewing function and other functional operations.

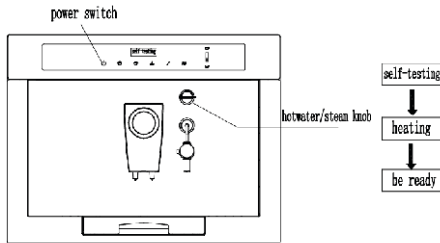

3.1 Single-brewing function

Press the single-brewing function key, the display screen will present “one cup” , after brewing ,it will show” be ready” ,then it allows the next cup of coffee brewing.

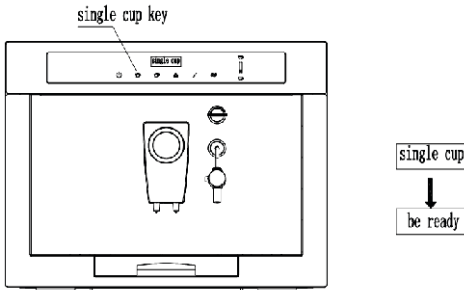

Remarks: 1.It won't stop brewing until you press down any button (single-cup key, double-cup key, steam key and automated washing key) ,on the condition that the bean has already been grinding.

2.While the coffee is releasing and the volume isn't to the setup, then revolve the volume knob and achieve the required water level.

3.2 Double-brewing function

Press the function key, and the display screen will present "double cup", until the process is finished, the words "be ready" will show on the display screen then it allows to choose repeat brewing or other functions.

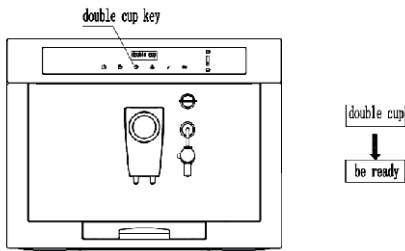

3.3 Coffee-powder brewing function

Use the exclusive powder-spoon to get 6.5-10 g coffee powder ,then press the coffee powder brewing key, and the screen will show "sample making" . When the brewing is finished, "be ready" will be shown on the screen, at this moment, it allows to choose the repeated brewing or other functions .

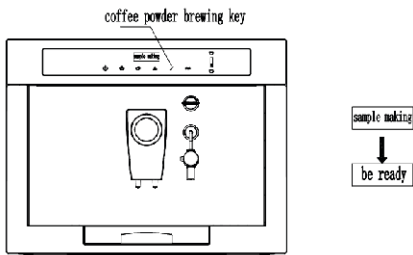

3.4 Steam function key

Press the key and the screen will show " steam preparing" ,until the heating step is finished, the words on the display screen will change into " be ready".

Right now, if you intend to utilize the steaming function, please revolve the according key anticlockwise and place it in the symbol position .while using, it presents "releasing steam" . then revolve the knob to close , at the same time, it helps to make cappuccino and milk frother.

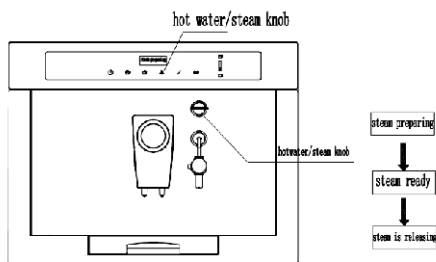

Remarks: if you need to choose other functions after making steam, you must exit the steam function first, operations: press the steam function key again, the screen will present "please open the steam knob", until the words "close the knob" show up in the screen, then revolve the knob to the closed position, meantime, the screen will present " be ready", and you are allowed to choose other functions right now.

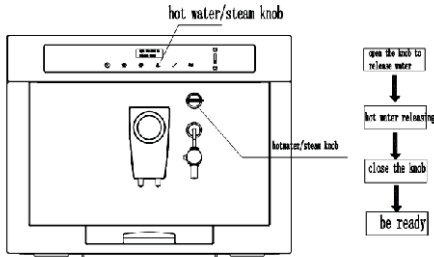

3.5 Self-cleaning function key

Press down the key, the screen will present "self-cleaning". when the cleaning is completed, the words "be ready" will be showed up again.

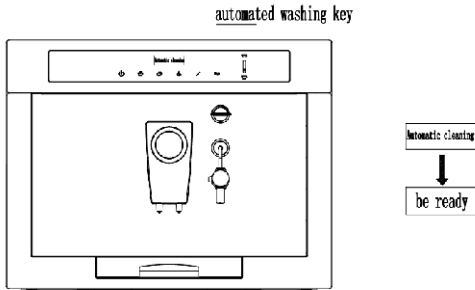

3.6 Methods of handling with shortage of water

In the process of using, if the display screen present the words "shortage of water", you need to check whether there is enough water in the tank, and add more water into it. After that, please revolve the steam/hot water knob, you can read the words "releasing water" on the display screen. wait until the water drains smoothly, the words on the screen will turn to "please close the knob". Close the knob and the screen will show "be ready", then you can continue other functional operations.

3.7 Coffee powder fineness adjusting knob

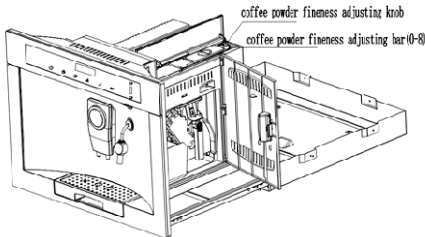

The bigger of the number in Fineness adjusting knob, the finer of the power; the smaller of the number in fineness adjusting knob, the coarser of the power, level numbers are carved from 0 to 8, level 0 means finest and level 8 coarsest.

After adjusting the powder fineness, it will be in the adjusted condition until the third cup of coffee is made out.

3.8 Coffee powder volume adjusting knob

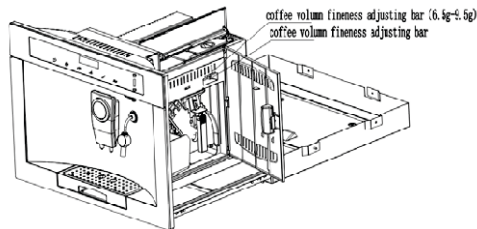

Coffee powder volume adjusting mark: the sign “-” means the least quantity 6.5g, while “+” means most quantity 9.5g.

3.9 total number of cup query

Long press the power switch, a series of numbers will be showed on the LCD, and it means the total number of cups. Pressing the power switch once more time, the machine will exit the function.

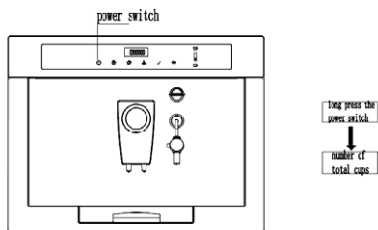

4 .Handling with the operational problems

No.	problem	Handling methods
1	The LCD show “please stall properly the dump container”	Check if the dump container and drip tray are in the right place
2	The LCD show “please stall the brewing unit”.	Restall the brewing unit; take it out first ,then put it back, the sound “kata” shows the successful action in pushing the unit into its original place.

3	Grinder motor work for a while, the screen prompts" please add more beans", while the bean hopper has bean.	Check the coffee powder size. If it is too slight ,adjust the fineness and volume knob to the appropriate position.
4	Shortage of water while the machine is working	Operates as the hints on the display screen ,
5	The display screen show" please add more water" while the tank gets enough water and the coffee fails to be made out in the brewing process.	1. operates as the hints on the screen, open the hot water knob to evacuate, if it can evacuate naturally , then means the brewing unit is stuck 2. if it fails to evacuate, then means the flowmetre needs changing and dredge
6	Water leakages from swing door	The water return hole is plugged, need to be professional repaired
7	Water goes into the drip tray (one cup/10 ml is normal, which is called reflux. while the volume is over 17ml,that meansreflux valve ,failing in effective dwelling ,cause the leakage.);	Replace the return valve (it should be replaced by the professional maintenance staff.
8	Powder pipe is wet and unshaped	Coffee powder is not enough, please adjust the volume knob .
9	Water is in the dump container.	Replace the seal ring(32.5*4)
10	Heat the NTC AD shows it is being heating all the time while the water is cold.	Thermostat is tripped (replace it by professional maintenance staff.
11	the display screen shows (please close the door) when the swing door is open	Close the swing door
12	The shortage of beans	Check if there is enough beans in the bean hopper

5 Brewing unit replacement, takeout and cleaning.

5.1 way to take out the brewing unit

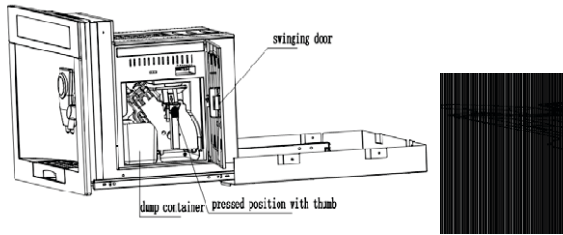

The procedures of taking out the brewing unit.

1. Open the swing door
2. Take out the dump container.
3. Hold the handle of the brewing unit, press down the ear of funnel with your thumb to make the toner hopper move outside, then draw it out.

5.2 Way to put in the brewing unit

The procedure to put in the brewing unit:

1. Press down the ear of funnel with your thumb and the tone hopper will move outwards. Then make the positioning bar and the base move upwards.

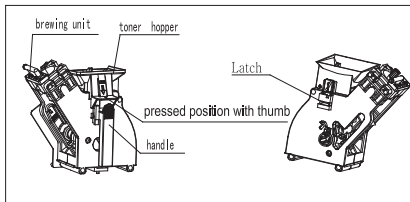

2. Check if the two positioning bar are in the coincident points.

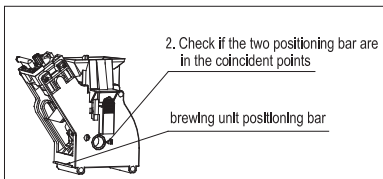

3. Propel the two positioning bars into the groove, press the toner hopper with your thumb. When the sound 'kata' was heard, it means the successful way to put in the brewing unit. Next, put in the dump container and close the swing door ,no hints show on the display screen, thus all the spare parts are in the right place.

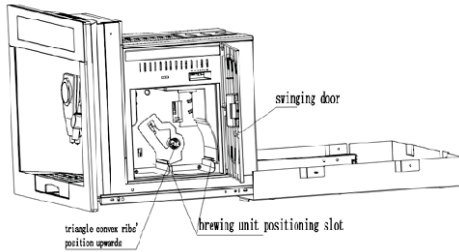

6. Daily maintenance

1. Water tank:

It should be on daily cleaning after each use, inject fresh water before using and better keep the water temperature below 35 °C and use pure water.

2. Brewing unit

Clean and clear it up when finishing daily household use. In the normal state, just use fresh water to clean it every two weeks. If it is for restaurant use, then it should be on daily cleaning.

3. Milk frother cleaning

Clean up the milk stuck on the nozzle in time after each frothing and then let out water while the machine is on the shutdown status, please take down the milk frother, clean it up and put it back.

www.hometech.pk